

CoAiro XP200

USER MANUAL



READ AND SAVE THESE INSTRUCTIONS

The CoAiro-XP200 is a whole house ventilating dehumidifier that is integrated into the heating and cooling system to provide the ultimate in comfort, health and property protection through:

- Dehumidification
- Fresh Air Ventilation (Optional)
- Air Filtration

READ AND SAVE THESE INSTRUCTIONS

Table of Contents

Important Notes	1
Warranty Registration	1
Specifications	2
How it Works	2
Installation Requirements	2
Installation	3
Electrical Requirements	4
Water (Condensate) Removal	4
Ducted Applications	4
Unit Diagram	5
Maintenance	6
Dehumidifier Storage	6
Troubleshooting	7
Remote Control Instructions	8
Spare Parts	10
Limited Warranty	11
Warranty Information	12

Important Notes

- The design of the dehumidifier is suitable for indoors space that is protected from any forms of flooding or rain.
- Always connect your dehumidifier using a grounded, dedicated electrical connection that is GFCI protected with at least 15 amp capacity.
- The use of any other type of wiring will void your warranty.
- Install dehumidifier according to all applicable local, state, and national codes.
- Be sure to follow your GFCI maintenance instructions. you will typically need to test the operation of the trip circuit monthly.
- For ease of testing and operation, it may be helpful to put the test switch and indicator lights in a convenient location.
- The design of the dehumidifier is suitable for indoors space that is protected from any forms of flooding or rain.
- It is important to install the dehumidifier in a room that has enough space. This is to allow you to access the side and/or back panels easily for service and maintenance purposes.
- Your dehumidifier should only be repaired by a qualified technician.
- Do not insert objects or your fingers into the inlet or discharge.
- Do not use water to clean the exterior of the dehumidifier. To clean unit, unplug from power, then use a damp cloth to wipe the exterior.
- Do not stand on dehumidifier or place objects on it.
- Unless otherwise noted, all maintenance should be done with the unit power off..

Warranty Registration

Your dehumidifier comes with an extensive warranty. To register your unit simply fill out and return the warranty form provided in your dehumidifier box.

For future reference, write down the model, serial number, and date of purchase for your dehumidifier. This information is necessary for seeking assistance in the future and can be found on the data label on the side of the unit.

Model Number:

Date of Number:

Serial Number:

For additional questions concerning your dehumidifier, the following options are available:

- Call Unipdry at 888-977-1520.
- Email: support@coairo.com

Specifications

Capacity@80°F/60%RH: 120 Pints Per Day
Airflow @ 0.0" SP: 300CFM
Operating Temp. Range: 33-105°F
Operating Relative Humidity Range: 36%-90%
COP: 2.8 L/kWh
Refrigerant: R410A
Amperage Usage: 7.6 Amps
Power Supply: 115V/60Hz/Single Phase
Outlet Requirement: 15 Amp, 3 Prong, GFCI
Sound Level: 60 dBa
Dimensions LxWxH: 23.75" x 14" x 16"
ETL Listed: Yes

How it works

Unipdry dehumidifiers use an integrated humidistat to monitor the conditioned space. When the relative humidity goes above the selected setpoint, the dehumidifier will energize. Air is then drawn across an evaporator coil, which is cooler than the dew point of air. This means moisture will condense out of the air. The air is then reheated through the condenser coil and distributed back into the room.

Installation Requirements

- The area where the dehumidifier is located should be sealed with a vapor barrier.
- If the unit is installed in a crawl space, all vents should be sealed.
- For proper ventilation, neither the inlet or discharge should be positioned against a wall. The inlet needs a minimum of 12" clearance and the discharge requires a minimum of 36" clearance.
- For the best air diffusion, install the unit so that a side panel faces the wall.
- Unipdry dehumidifiers are only intended for operation when the unit is upright and level with the feet on the ground (unless using a Unipdry Hanging Kit).

Installation

Location

The good thing with this device is that its location is versatile. It can be installed in a variety of areas to ensure that the installer meets the client's needs. But still, the following aspects should be considered:

- The location chosen should provide steady access to 10" power cord and a 115 VAC power outlet.
- It should be located near a suitable drain or floor. An 8' drain hose is provided to help boost drainage.
- The device should be mounted 4" above the drain.
- The unit should never be located very close to open water.
- Also, ensure that you avoid any possible obstruction to the air inlet and exhaust. Give it at least one foot for aeration.

The simplest form of installation is to place the unit in a space where ducting is not too necessary. Recirculation will promote the speed at which the gadget works. Recirculation of air into the inlet could damage the unit system.

Duct Supply and Return

In order to promote the rate at which dehumidification occurs, you can add the supply and/or return duct to help circulate air. You can make use of the return duct to draw moist and warm air from the near ceiling in order to obtain optimal drying. In a simpler remote installation procedure, you can make use of the humid room and the Uni-P discharge room. The Uni-P dehumidifier inlet usually draws air from the room where it is installed. For that reason, this installation procedure works well if the unit is installed in a room that has got adequate air flow. Such rooms may include rooms with the wall grill, louvered doors, and/or high door undercut. Such conditions promote airflow and hence, eliminates the requirement to remote mount the humidity controller.

Warning: it is important that you first seek guidance from a qualified device operator before you opt to use the device as described above. The experts will provide you with instructions on how to complete the procedure. If backdraft devices are such as the hot water heater are present in the place that needs to be dehumidified, it is important that the manufacturer or certified service provider completes the installation.

It may be necessary to slightly pressurize and/or dehumidify the room if the dehumidifier is to be located in a smaller room that is separate from the main area that requires dehumidification. The purpose of pressurization is to make sure that any open combustion devices present in the room do not backdraft. Backdraft can be prevented by simply allowing the Uni-P dehumidifier to release dehumidified air into the room where it is located. It can also be prevented by installing a circulation pipe from the humid room into the dehumidifier inlet. All in all, there should be adequate air circulation between the two rooms for this procedure to work well.

Electrical Requirements

Normally, the CoAiro dehumidifier plugs into one major grounded outlet on a relatively 110 to 120 VAC 15 Amp circuit. In some cases the use of the GFCI (Ground Fault Circuit Interrupter) is advisable. The unit, however, is not suitable for areas affected by flooding too much rainfall.

Caution: in order to maintain proper drainage, it is advisable that you raise the unit high enough such that the outlet of the drain is at least 4" above the floor. Also, it must be fully supported under the base.

Water (Condensate) Removal

You can condensate the drains easily by gravity through the drain port. Use 0.75" male PVC NPT pipe. Also, route every single drain to drain. If possible install a trap. All in all, be careful when installing the drain pipe to the drain port. You can make use of an adjustable wrench to protect the drain port from damage. An optional water removal pump kit may be fixed if a lift is needed to dispose of the water. You can contact the company if you would like to order a pump kit.

When fixing the drain hose it is important to ensure that the feet are extended in a way that the device is raised two and a half feet from the ground. After the hose gets in contact with the ground, ensure that you coil the drain hose beneath itself or try to position a spacer to help lift the hose at least one feet from the ground. This way the process will create a trap that helps to ensure that the unit drains well.

Ducted Applications

Ducting the dehumidifier allows the unit to be in one room while conditioning an adjacent room. Both the inlet/return grille and the supply grille are designed for 10" flex ducting.

- Be sure to secure the ducting with tie wrap.
- Maximum total length of duct run = 10'
- Inlet and outlet duct adapters are optional accessories

Duct Adapter Installation

- Screw in the 4 screws on each duct adapter.

Flex Duct Installation

- Slide ducting over adapter and secure with tie wrap or clamps

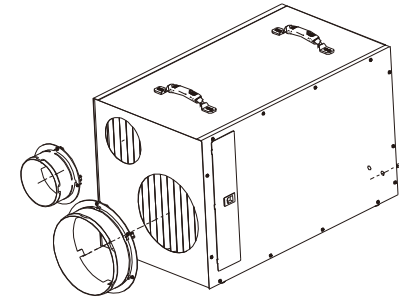

Unit Diagram

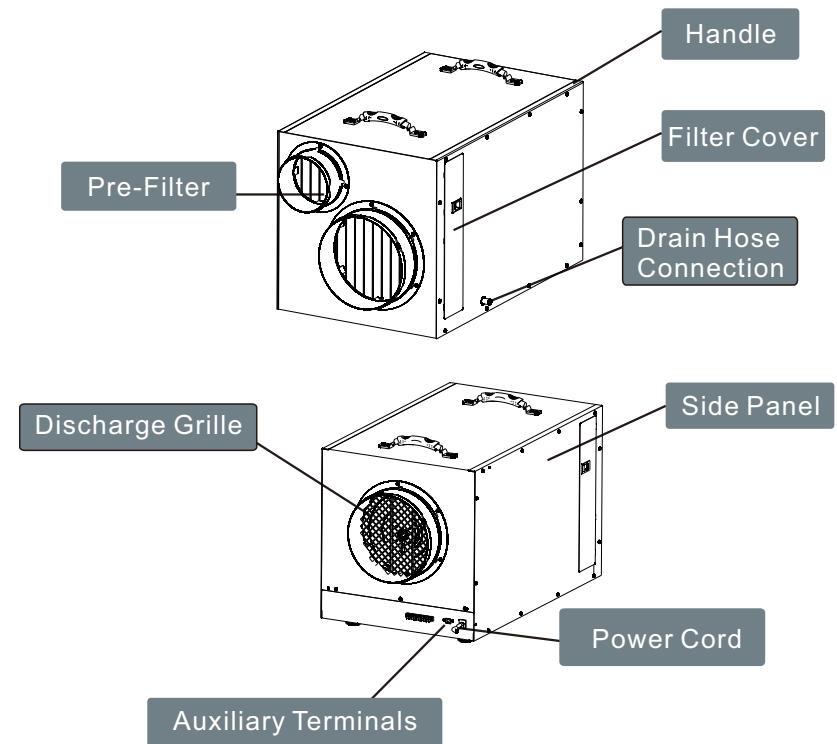

Maintenance

****For more detailed instructions, visit www.unipdry.com****

WARNING: Always unplug the unit before doing any maintenance.

Cleaning the Machine Body

- Use a soft, damp cloth to clean the exterior of unit. Do not use any soap or solvents

Coil Maintenance

Once per year, clean the coils with an approved coil cleaner. The coil cleaner should be a self-rinsing, foaming, cleaner, such as WEB® Coil Cleaner.

Cleaning the Filter

1. Unplug the unit.
2. For PreFilter:
 - a. Remove prefilter from inlet of machine.
 - b. Vacuum or wash with warm water (no soap).
3. For MERV-10/HEPA/Carbon Filters:
 - a. Replace as necessary- we recommend checking the filters at least 1x/year

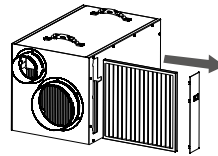

Electrical Access

- Unscrew the 13 screws on the side panel.
- Remove the screw on the control board cover.

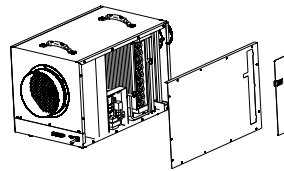

Dehumidifier Storage

If the unit will be stored for an extended period of time, complete the following steps:

1. Turn off the unit and allow it to dry.
2. Complete steps 1-3 in Advanced Pump Cleaning to clean out the pump reservoir.
3. Wrap and secure the power cord.
4. Cover the filter mesh.
5. Store in a clean, dry space.

Troubleshooting

Symptom	Cause	Solution
Display is Blank	Poor Connection	Verify that both ends of the cord are plugged in
	Power Outage	Reset power
No Airflow	Filter is dirty	Clean the Filter
	Air Inlet or Outlet is Blocked	Clean the blockage
Error Code:E1	Humidity Sensor or Communication Error	Check to ensure that the sensor wire is connected at both ends. If no issues are visible, the sensor may be faulty.
Error Code:E4	Problem with Pump	Verify that the pump is properly installed and functioning. If so, unplug the unit for two minutes, then restart.
Error Code:LO	Room Temperature is below 33°F	Increase the room temperature so it is within operating range (above 33°F). If error still displays, check sensor.
Error Code:HI	Room Temperature is above 105°F	Decrease the room temperature so it is within operating range (below 105°F). If error still displays, check the sensor
Tripped GFCI Outlet or Breaker	Not a Dedicated Circuit	Identify all sources connected to outlet and confirm source of trip. If it is dehumidifier, contact technical support. If not, move dehumidifier to dedicated circuit for future use.
	Defective GFCI Outlet	Replace Outlet
	Dirt, Dust, or Moisture on Outlet	Clean or Replace Outlet as necessary
	Lightning or External Electrical Surge	Reset or Replace Breaker/GFCI, as necessary
	Possible Dehumidifier Issue	If none of above options work, contact technical support

Remote Control Instructions

Unipdry Dehumidifiers can be controlled using an optional remote accessory. The remote connects to your dehumidifier via a 25' CAT 5 cable, with the integrated sensor giving you multiple options for monitoring surrounding conditions.

Example #1- Install the dehumidifier in the laundry room and duct it into the living room. Mount the remote in the living room and use the remote sensor.

Example #2- Install the dehumidifier in your crawl space with the remote mounted in your garage.

NOTE: The symbols indicated below only show when the remote is powered on.

1. On/Off (Power) Button



Press the on/off button and the machine will start running. Press the button again to turn the machine off.

2. Up Button/ Down Button

Use the up and down arrows to adjust the humidity level.

3. Mode

Use the mode button to switch between dehumidifier and a ducted application.

- The  symbol on the display indicates the sensor on the remote control is being utilized.
- The  symbol on the display indicates the sensor on the dehumidifier is being utilized.

4. Temperature

The T button changes the temperature reading on your remote. The remote comes from the factory in Celsius. Press this button once to switch to Fahrenheit.

5. Continuous

Press this button to switch the unit into continuous mode. "CONT." will appear on the display screen.

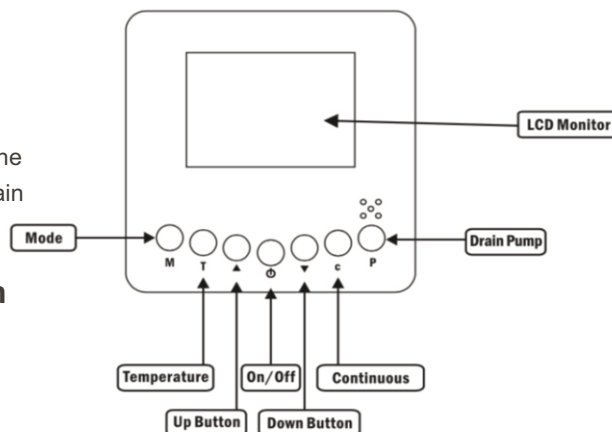

6. Drain Pump

Use this button if the unit will not be used for an extended period of time. This button will remove water from the pump reservoir.

Remote Control Instructions

1. Start the machine

- Press the power key to turn the dehumidifier on.

2. Adjust the settings

- Use the up and down arrow keys to adjust your desired setpoint (typically 50-55%)

3. Stop the machine

- Press the power button again and the dehumidifier will stop. Note that the fan will continue to operate for 1 minute after the unit has shut off. DO NOT DISCONNECT THE POWER CORD TO FORCE THE UNIT TO STOP.

4. Water Drainage

- The CoAiro XP200 has an integrated condensate pump. During normal operation, the CoAiro Xp200 will automatically drain as required.
- If you would like to store or move your unit, press the drain button to drain water from the pump reservoir. The drain will operate for 15 seconds each time the button is pushed. It may be necessary to push the button more than once.

Spare Parts

Display/Control	
N-100	Main Control Board
N-101	Display Board
N-102	RH/Temp. Sensor

Internal Components	
N-1209	Compressor
N-1206	Compressor Capacitor
N-1208	Coil Assembly
N-1207	Condensate Pump Assembly

Fan Components	
N-1210	Fan Motor
N-1211	Complete Fan Assembly
N-1205	Fan Capacitor

Filter + External Components	
N-1200	Prefilter
N-1201	MERV 8
N-1202	HEPA
N-1203	Carbon Filter
N-125	Foot adjustable

Cables	
N-120	Temp/RH Sensor Cable
N-121	Display Ribbon Cable
N-122	CaT: 5 Port Internal Cable

Duct + Ventilation Accessories	
N-1204	Supply Duct Collar Assembly

Limited Warranty

All warranty benefits apply to the original owner only. Warranty cannot be transferred or assigned.

5 Years (From Date of Purchase):

Unipdry warrants the dehumidifier will operate free of defects in workmanship and materials. At its discretion, Unipdry will repair or replace any malfunctioning components, free of charge excluding transportation costs.

Customer Responsibilities:

In order to take advantage of the warranty service, the customer must do the following:

1. Customer must provide normal care and maintenance (including, but not limited to cleaning filters, coils and pumps)
2. Removal and re-installation of unit is the sole responsibility of owner.
3. If customer cannot return unit to certified repair center, all costs associated with freight shipment are borne by the customer. In addition, all duties related to freight shipments, including but not limited to palletizing, wrapping, labeling, and pickup are associated with customer.
4. If shipped, customer is responsible for all risk of loss or damage.

Warranty Procedure:

1. Customer must mail in warranty registration card to Unipdry. If no card is submitted, warranty period will begin the day the shipment left the warehouse. Please be sure to record serial # and date of installation in the spaces provided on page 2 of the manual. You will need this information to receive an RA number.
2. If warranty service is necessary, customer must contact Unipdry Tech Support by phone 888-977-1520 to receive a Return Authorization (RA number).
3. Once an RA has been issued, it is the customer's job to bring the unit to a certified repair center. If this is not an option, shipping will be arranged to bring the unit back to the Unipdry warehouse (at the expense of the customer).
4. After the unit has been received by Unipdry (whether at a repair center or the warehouse), an initial inspection will be completed, if it is determined to be an invalid warranty claim (see exclusions below), unit will only be completed after receiving payment from customer for all associated costs.
5. If unit is defective, the necessary parts will be repaired or replaced and the unit will be available for pickup at certified repair center or returned via freight shipment (at customer's expense). Keep in mind that work is only done during normal working hours. After being repaired, all units are required to go through a rigorous testing process prior to being returned to customer.
6. Once a part is repaired and the dehumidifier is returned, the original warranty period still applies (no extensions)

Warranty Exclusions

DAMAGE DUE TO THE FOLLOWING IS NOT COVERED UNDER WARRANTY

1. ACTS OF NATURE- INCLUDING BUT NOT LIMITED TO:

- FLOODING
- FIRE
- WATER DAMAGE
- HURRICANE/STORM DAMAGE

2. IMPROPER USAGE- INCLUDING BUT NOT LIMITED TO:

- POOL/SPA/TUB APPLICATIONS
- MISUSE, ABUSE, OR TAMPERING WHETHER INTENTIONAL OR ACCIDENTAL
- IMPROPER INSTALLATION OR DESIGN
- IMPROPER VOLTAGE
- LACK OF NORMAL CARE
- FAILURE TO FOLLOW INSTRUCTIONS

3. CORROSION

4. FREEZING

5. ANY ADDITIONAL COSTS DUE TO CHANGES IN LAWS OR BUILDING CODES

6. FREIGHT CHARGES

7. ANY COSTS DUE TO LOST PROFIT OR DELAY

8. DAMAGE TO PROPERTY

9. CAUSE BEYOND CONTROL

10. CONSUMABLE PARTS, INCLUDING BUT NOT LIMITED TO:

- FILTERS
- BATTERIES
- POWER CORDS
- VALVES
- SWITCHES
- RUBBER PARTS

11. DIRECT, INDIRECT, COLLATERAL OR INCONSEQUENTIAL DAMAGES OF ANY KIND

THE WARRANTIES AND LIABILITIES SET FORTH ARE IN LIEU OF ALL OTHER WARRANTIES EXPRESSED OR IMPLIED, IN LAW OR IN FACT, INCLUDING IMPLIED WARRANTIES OF MERCHANTABILITY AND FITNESS FOR PARTICULAR PURPOSE. Unipdry's total liability, regardless of nature of claim shall not exceed original purchase price of the product. if a product or component is replaced while under warranty, the applicable warranty period shall not be extended beyond the original warranty time period.

The foregoing shall constitute the total liability of seller in the case of defective performance of all or any of the equipment or services provided to buyer. buyer agrees to accept and hereby accepts the foregoing as the sole and exclusive remedy for any breach or alleged breach of warranty by seller.

Any dishonesty or fraud in connection with Unipdry warranty thoroughly voids all warranty policies. Unipdry expressly reserves the right to pursue legal action in the event of dishonesty, fraud, or attempted fraud.